



# HOW TO ASSEMBLE

## STEEL WORK BENCH™

### IMPORTANT!

Please read these instructions carefully before starting assembly.  
Keep these instructions in a safe place for future reference.

[www.canopia.com](http://www.canopia.com)



A member of  
Palram Industries Ltd.

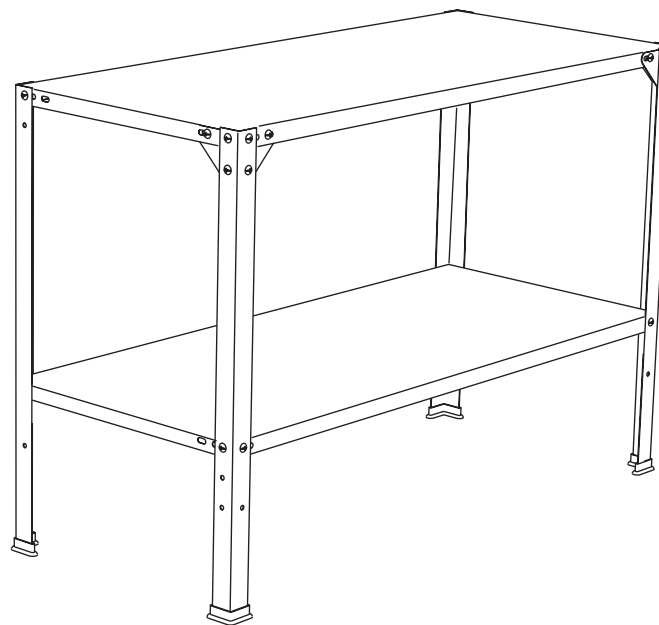



# 1

## PARTS REQUEST

**In the case of missing or damaged parts, do not return product to store.**

Go to the link below or scan the QR code for help, it will direct you to a form that will help us assist you as soon as possible.



SCAN ME

Contact us on our website:  
[bit.ly/3js7yZi](https://bit.ly/3js7yZi)

# 2

## ASSEMBLY ASSISTANCE

If you need any technical assistance in assembling your product, go to the link below or scan the QR code for help. It will direct you to a form that will help us assist you as soon as possible.



SCAN ME

Contact us on our website:  
[bit.ly/3kqqFEc](https://bit.ly/3kqqFEc)



## CUSTOMER SUPPORT



SCAN ME

# WE ARE HERE TO HELP

For general questions: [bit.ly/3kY07dP](https://bit.ly/3kY07dP)

### USA



877-627-8476



[hobbyservice@poly-tex.com](mailto:hobbyservice@poly-tex.com)

### CANADA



905-5646007



[sales@footprintproducts.com](mailto:sales@footprintproducts.com)

### UNITED KINGDOM · IRELAND



01302-380775



[customer.serviceUK@palram.com](mailto:customer.serviceUK@palram.com)

### GERMANY



0180-522-8778



[customer.serviceDE@palram.com](mailto:customer.serviceDE@palram.com)

### FRANCE · BELGIUM



+33-169-791-094



[customer.serviceFR@palram.com](mailto:customer.serviceFR@palram.com)

### ISRAEL



04-848-6816



[info.il@palram.co.il](mailto:info.il@palram.co.il)

### ITALY · NETHERLANDS · PORTUGAL · SPAIN



+33-169-791-094



[customer.serviceFR@palram.com](mailto:customer.serviceFR@palram.com)

### AUSTRIA · LUXEMBURG · LIECHTENSTEIN



+49-180-522-8778



[customer.serviceDE@palram.com](mailto:customer.serviceDE@palram.com)

### AUSTRALIA



03-9219-4444



[salesvic@palram.com](mailto:salesvic@palram.com)

NORWAY · SWEDEN · ARGENTINA · GREECE · GREENLAND · ICELAND · ESTONIA · JAPAN · LATVIA · LITHUANIA  
MAURITIUS · MEXICO · ROMANIA · RUSSIA · TURKEY · UZBEKISTAN · UKRAINE · SWAZILAND · KOREA



+972-4-848-6816



[customer.service@palram.com](mailto:customer.service@palram.com)



## CUSTOMER SUPPORT



SCAN ME

# WE ARE HERE TO HELP

For general questions: [bit.ly/3kY07dP](https://bit.ly/3kY07dP)

### AUSTRALIA - GREENHOUSES

 03-9544-6-999

 [info@mazedistribution.com.au](mailto:info@mazedistribution.com.au)

### HUNGARY · SLOVAKIA

 +420-493-523-523

 [servis@garland.cz](mailto:servis@garland.cz)

### NEW ZEALAND

 0800 800 880

 [customer.service@palram.com](mailto:customer.service@palram.com)

### DENMARK

 07-575 42 70

 [post@nshnordic.com](mailto:post@nshnordic.com)

### SOUTH AFRICA

 011-397-7771

 [receptionza@palram.com](mailto:receptionza@palram.com)

### CROATIA · SLOVENIA

 0599-37-057

 [info@ms-viscom.com](mailto:info@ms-viscom.com)

### CZECH REPUBLIC

 0493-523-523

 [servis@garland.cz](mailto:servis@garland.cz)

### FINLAND

 Neuvonta: 09-6866720  
Tuki / Varaosat: 050-3715350

 [www.horisontenterprises.fi](http://www.horisontenterprises.fi)  
[tuki@horisontenterprises.fi](mailto:tuki@horisontenterprises.fi)

### POLAND

 Infolinia: 801-011-929  
22-349-93-36

 [kontakt@ogrodosfera.pl](mailto:kontakt@ogrodosfera.pl)

### CYPRUS

 0224-971-13

 [alpaco@alpacodomica.com](mailto:alpaco@alpacodomica.com)  
[www.alpacodomica.com](http://www.alpacodomica.com)

### SWITZERLAND

 062-287-33-77

 [info@ritter.ch](mailto:info@ritter.ch)

# Contents

